

**İş** Sağlığı **ve**  
Güvenliği  
Kapsamında  
**Renkler**

# RENKLER

- Tehlike İletişimini lisandan bağımsız kılmak ve hızlandırmak adına Renkler hayatımızın bir çok alanında yer almaktadır, İş Sağlığı ve Güvenliği uygulamalarında da çok etkin olarak kullanılmaktadır.

- 1-) ISO 7010 2019-07 Grafik Semboller – Emniyet Renkleri ve İşaretleri – Tescilli Güvenlik İşaretleri
- 2-) TS ISO 3864-1 : 2016 Grafik Semboller – Emniyet İle İlgili Renk ve İşaretler –  
Bölüm 1: İşyerleri ve Halka Açık Alanlardaki Emniyet İşaretleri için Tasarım Prensipleri
- 3-) Sağlık ve Güvenlik İşaretleri Yönetmeliği Tarih: 11.09.2013 Resmi Gazete Sayısı: 28762
- 4-) Sanayi Gaz Tüpleri Renkleri
- 5-) Oksijen- Yanıcı Gaz Kesme ve Kaynak İşlerinde Renkler TS EN ISO 3821 Gaz Kaynak Donanımları Kaynak Yapma, Kesme ve Benzeri İşler İçin Lastik Hortumlar standardı imalat ve satış safhalarında zorunlu olarak uygulanacaktır.
- 6-) Mekanik Tesisatlarda Renkler
- 7-) Kişise Koruyucu Donanımlarda Renkler
- 8-) Muhtelif İş Güvenliği Uygulamalarında Renkler

1-) ISO 7010 2019-07 Grafik Semboller  
– Emniyet Renkleri ve İşaretleri –  
Tescilli Güvenlik İşaretleri

## **Kapsam**

Bu doküman kaza önleme, yangın önleme, sağlık tehlikeleri ve acil durum tahliyesiyle ilgili emniyet işaretlerini tanımlar.

Herbir Emniyet işaretinin şekli ve rengi ISO 3864-1 'e göre grafik sembollerin tasarımı ISO 3864-3'e göredir.

Bu doküman insanların emniyetiyle ilgili tüm alanlarda uygulanabilir.

Ancak, demir yolu, karayolu, nehir, deniz ve hava trafiğini yönlendirmek için kullanılan işaretlere ve genel anlamda farklılık arz edebilecek bir düzenlemeye konu olan sektörlerle uygulanmaz.

Table 2 — Summary of all safety signs















	Category				
	E	F	M	P	W
	Evacuation route, location of safety equipment, or safety facility, safety action (safe condition signs)	Fire equipment signs	Mandatory action signs	Prohibition signs	Warning signs
Safety sign					
Reference number	E001	F001	M001	P001	W001
Referent	Emergency exit (left hand)	Fire extinguisher	General mandatory action sign	General prohibition sign	General warning sign
Safety sign					
Reference number	E002	F002	M002	P002	W002
Referent	Emergency exit (right hand)	Fire hose reel	Refer to instruction manual/booklet	No smoking	Warning: Explosive material
Safety sign					
Reference number	E003	F003	M003	P003	W003
Referent	First aid	Fire ladder	Wear ear protection	No open flame; Fire, open ignition source and smoking prohibited	Warning: Radioactive material or ionizing radiation

Table 2 (continued)













	Category				
	E	F	M	P	W
	Evacuation route, location of safety equipment or safety facility, safety action (safe condition signs)	Fire equipment signs	Mandatory action signs	Prohibition signs	Warning signs
Safety sign					
Reference number	E004	F004	M004	P004	W004
Referent	Emergency telephons	Collection of firefighting equipment	Wear eye protection	No thoroughfare	Warning: Laser beams
Safety sign	withdrawn				
Reference number	E005	F005	M005	P005	W005
Referent	Direction, arrow (90° increments), safe condition	Fire alarm call point	Connect an earth terminal to the ground	Not drinking water	Warning: Non-ionizing radiation
Safety sign	withdrawn				
Reference number	E006	F006	M006	P006	W006
Referent	Direction, 45° arrow (90° increments), safe condition	Fire emergency telephons	Disconnect mains plug from electrical outlet	No access for forklift trucks and other industrial vehicles	Warning: Magnetic field

Table 2 (continued)











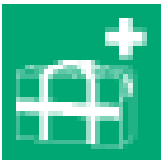
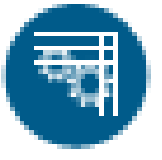

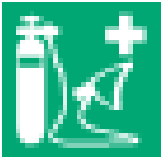



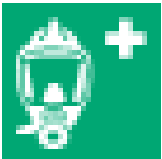





	Category				
	E	F	M	P	W
	Evaluation results, location of safety equipment, or safety facility, safety advice (safe condition signs)	Fire equipment signs	Mandatory action signs	Prohibition signs	Warning signs
Safety sign		—			
Reference number	0007	—	0007	P007	W007
Reference	Medical gas bag	—	Check guard	Do not use the lift for people	Warning: Optical radiation
Safety sign		—			
Reference number	0010	—	0010	P010	W010
Reference	Oxygen transmission	—	Keep locked	Do not wear gloves	Warning: Oxidizing substance
Safety sign		—			
Reference number	0019	—	0019	P019	W019
Reference	Emergency escape, breathing device	—	Sound horn	No photography	Warning: Pressurized cylinder



Table 2 (continued)

	Category				
	E	P	M	F	W
	Evacuation route, location of safety equipment or safety facility, safety advice (safe conditions signs)	Fire equipment signs	Mandatory action signs	Prohibition signs	Warning signs
Safety sign		—			
Reference number	0000	—	0000	0000	0000
Reference	Embarkation ladder	—	Wear personal flotation device	No sailing	Warning Unstable boat
Safety sign		—			
Reference number	0000	—	0000	0000	0000
Reference	Hand assistance slide	—	Keep children under supervision in aquatic environment	No windowing	Warning Sharks
Safety sign		—	—		
Reference number	0000	—	—	0000	0000
Reference	Hand assistance slide	—	—	No manually powered craft	Warning Group officials advised
Safety sign		—	—		
Reference number	0000	—	—	0000	0000
Reference	Survival clothing	—	—	No mechanically powered craft	Warning Tonnage based area

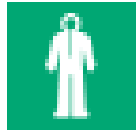
2-) TS ISO 3864-1 : 2016 Grafik  
Semboller – Emniyet ile ilgili Renk ve  
İşaretler –

Bölüm 1: İşyerleri ve Halka Açık  
Alanlardaki Emniyet İşaretleri için  
Tasarım Prensipleri

## 1 Kapsam

Bu standard, kaza önleme, yangından korunma, sađlık tehlike bilgileri ve acil durum tahliyesi amacıyla iş yerleri ve halka açık yerlerde kullanılacak emniyet işaretleri için emniyet tarif renkleri ve tasarım prensiplerini kapsar. Bu standard ayrıca, emniyet işaretleri içeren standardlar geliştirirken kullanılacak temel prensipleri kapsar.

ISO 3864'ün bu bölümü, iş yerlerine, emniyetle ilgili soruların yöneltilebileceđi bütün yerler ve bütün sektörlerle uygulanabilir. Ancak, demir yolu, kara yolu, nehir, deniz ve hava trafiđini yönlendirmek için kullanılan işaretleme ve genel anlamda, farklılık arz edebilecek bir düzenlemeye konu olan sektörlerle uygulanamaz.

**Not -** Bazı ülkelerin yasal düzenlemeleri ISO 3864'ün bu bölümünde verilen düzenlemelerden bazı yönlerden farklılık arz edebilir.

**Çizelge 1 – Geometrik şekiller, emniyet renkleri ve karşıt renklerin genel anlamı**

Geometrik şekil	Anlam	Emniyet rengi	Karşıt renk	Grafik sembol rengi	Kullanım örneği
 Kögegen çubuklu çember	Yasaklama	Kırmızı	Beyaz <sup>a)</sup>	Siyah	<ul style="list-style-type: none"><li>– Sigara içilmez</li><li>– Yetkisiz taşıt giremez</li><li>– İçilmez</li></ul>
 Çember	Zorunlu eylem	Mavi	Beyaz <sup>a)</sup>	Beyaz	<ul style="list-style-type: none"><li>– Göz koruması giyin</li><li>– Kişisel koruyucu donanım giyin</li><li>– İşe başlamadan önce elektrik akımını kesin</li></ul>
 Eşkenar üçgen	Uyarı	Sarı	Siyah	Siyah	<ul style="list-style-type: none"><li>– Tehlike sıcak yüzey</li><li>– Tehlike asit</li><li>– Tehlike yüksek gerilim</li></ul>

Çizelge 1'in devamı

 Kare  Dikdörtgen	Emniyet koşulu Kaçış imkânı Emniyet donanımı	Yeşil	Beyaz <sup>a)</sup>	Beyaz	<ul style="list-style-type: none"><li>- İlk yardım odası</li><li>- Yangın çıkışı</li><li>- Yangın toplanma noktası</li></ul>
 Kare  Dikdörtgen	Yangın emniyeti	Kırmızı	Beyaz <sup>a)</sup>	Beyaz	<ul style="list-style-type: none"><li>- Yangın alarmı çağrı noktası</li><li>- Yangın söndürme teçhizatı</li><li>- Yangın söndürücü</li></ul>
 Kare  Dikdörtgen	Tamamlayıcı bilgi	Beyaz veya emniyet işaretinin rengi	Siyah veya ilgili emniyet işaretinin karşıt rengi	İlgili emniyet işaretinin sembol rengi	Grafik sembolle verilen mesajı yansıtacak uygunlukta

<sup>a)</sup> Karşıt renk beyaz Çizelge 4'te tarif edildiği üzere gün ışığı koşulları altında fosforlu malzeme için karşıt rengi içermektedir.

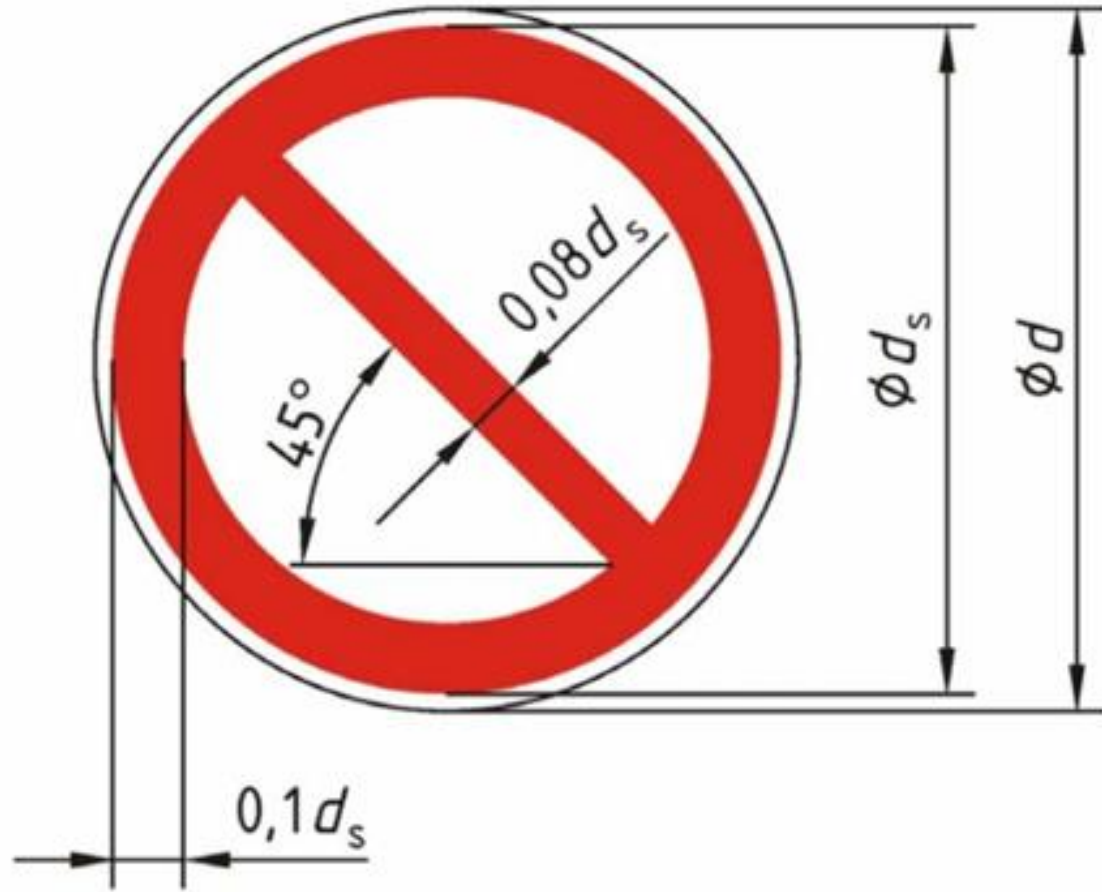

İşaretin renkleri aşağıda verildiği şekilde olmalıdır:

Arka zemin rengi

beyaz

Dairesel şerit ve köşegen çubuğu

kırmızı

Grafik sembol

siyah

Sınır

beyaz

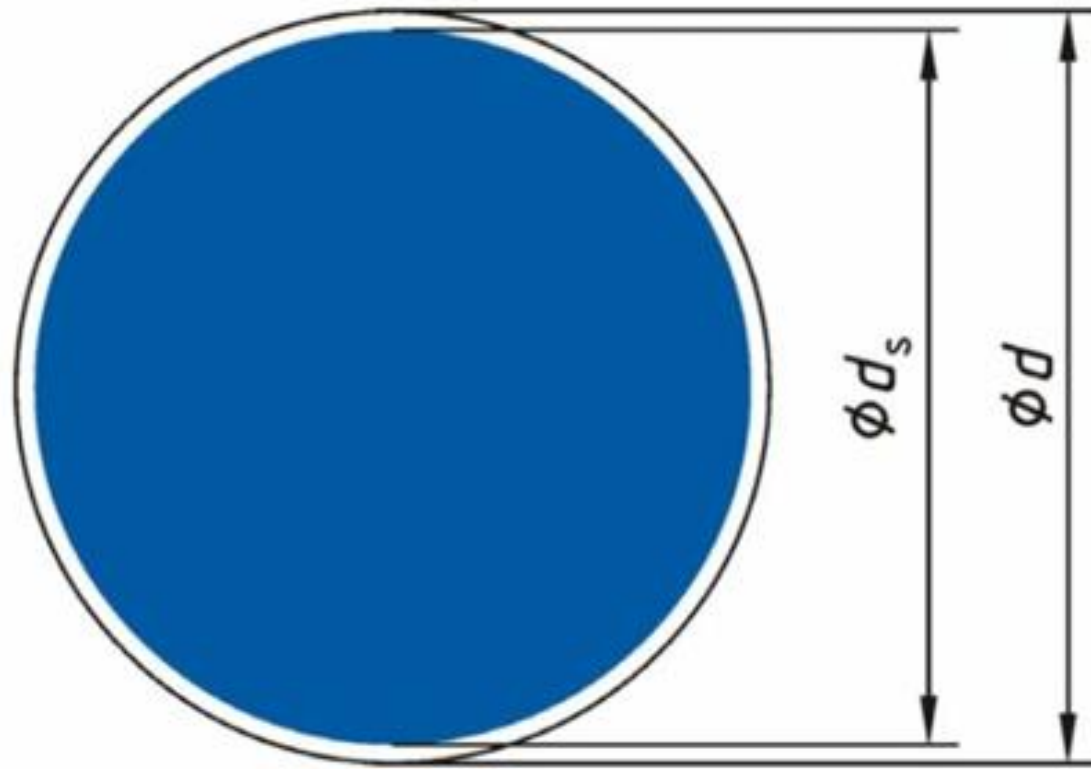

İşaretin renkleri aşağıda verildiği şekilde olmalıdır:

Arka zemin rengi

mavi

Grafik sembol

beyaz

Sınır

beyaz

Mavi enmiyet rengi tüm işaretin en azından %50'sini kaplamalıdır

#### 7.4 Uyarı İşaretleri

Uyarı eylem işaretleri Şekil 3'te verilen yerleştirme kurallarına uygun olmalıdır.

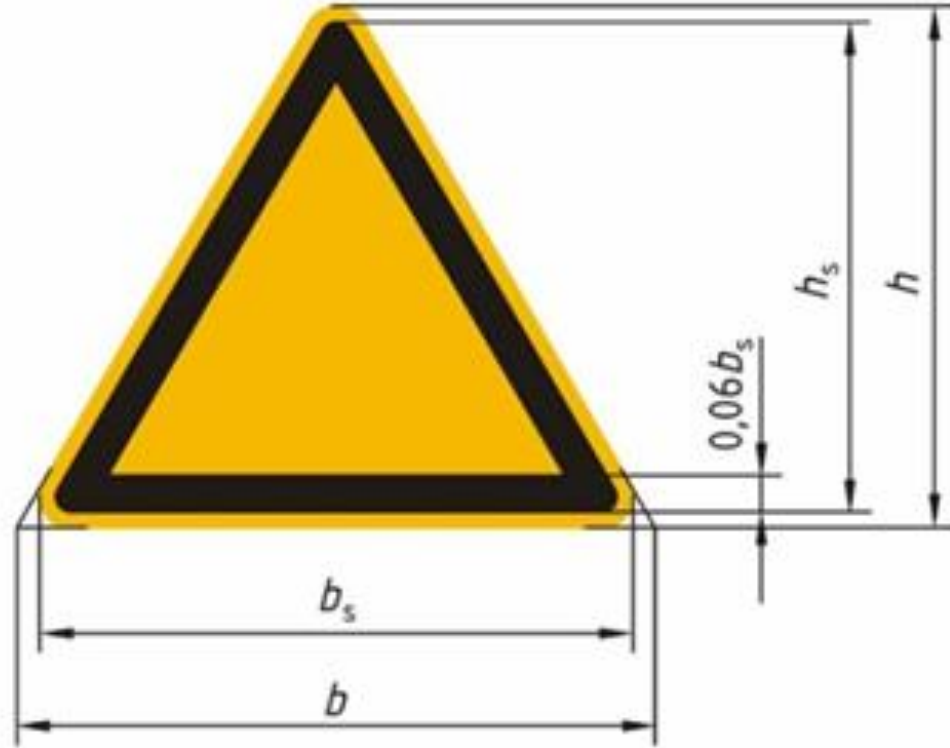

İşaretin renkleri aşağıda verildiği şekilde olmalıdır:

Arka zemin rengi	sarı
Üçgen şerit	siyah
Grafik sembol	siyah

Emniyet rengi tüm işaretin en azından %50'sini kaplamalıdır.



## 9 Emniyet işaretinin yerleşimi

Şeritler yaklaşık 450'lik eğime sahip eşit kalınlıktadır (Şekil 17 ilâ Şekil 20).

Tehlikeli yerleri belirten emniyet işaretinin renkleri, Şekil 17'de gösterildiği gibi sarı ve karşıt siyahın bir birleşimi olmalıdır.



**Renk birleşimi: Sarı ve karşıt siyah**

Şekil 17 – Tehlikeli yerleri belirtmek için emniyet işareti

Yasak veya yangınla mücadele donanım yerini belirten emniyet işaretinin renkleri, Şekil 18'de gösterildiği gibi kırmızı ve kontrast beyazın bir birleşimi olmalıdır.



**Renk birleşimi: Kırmızı ve karşıt beyaz**

Şekil 18 –Yasak veya yangınla mücadele donanımı yerini belirtmek için emniyet işareti

Zorunlu bir talimat belirten emniyet işaretinin renkleri, Şekil 19'da gösterildiği gibi mavi ve kontrast beyazın bir birleşimi olmalıdır.



**Renk birleşimi: Mavi ve karşıt beyaz**

Şekil 19 – Zorunlu bir talimat belirtmek için emniyet işareti

Emniyetli bir durumu belirten emniyet işaretinin renkleri, Şekil 20'de gösterildiği gibi yeşil ve kontrast beyazın bir birleşimi olmalıdır.



**Renk birleşimi: Yeşil ve karşıt beyaz**

Şekil 20 – Emniyetli bir durumu belirtmek için emniyet işareti

**Çizelge A.1 - Renk düzen sistemlerinden emniyet renkleri örnekleri**

Renk	DIN 5381 DIN 6164	RAL <sup>a</sup>	Munsell <sup>a</sup>	AFNOR NF X08-002 ve X08-010	NCS
Kırmızı	7,5 : 8,5 : 3	RAL 3001	7,5R 4/14	N°2805	S 2080-R
Mavi	16,7 : 7,2 : 3,8	RAL 5005	2,5PB 3/10	N°1540	S 4060-R90B
Sarı	2,5 : 6,5 : 1	RAL 1003	10YR 7/14	N°1330	S 1070-Y10R
Yeşil	21,7 : 6,5 : 4	RAL 6032	5G 4/9	N°2455	S 3060-G
Beyaz	N : 0 : 0,5	RAL 9003	N 9,5	N°3665	S 0500-N
Siyah	N : 0 : 9	RAL 9004	N 1	N°2603	S 9000-N

<sup>a</sup> RAL ve Munsell ticari olarak mevcut renk düzen sistemleri örnekleridir. Bu bilgi, bu standard kullanıcıları için verilmektedir ve ISO tarafından bu ürünlerin kullanımına yönelik bir destek anlamı taşımaz.

3-) Saęlık ve Gvenlik İřaretleri  
Ynetmelięi Tarih: 11.09.2013  
Resmi Gazete Sayısı: 28762

# Sađlık ve Gvenlik İřaretleri

- SAĐLIK VE GVENLİK İŐARETLERİ  
YNETMELİĐİ

- Resmi Gazete

Tarih: 13.09.2013; Sayı: 28762





# Emredici işaretler



# Emredici işaretler



# Emredici işaretler



# Emredici işaretler



# Emredici işaretler



# Yasaklayıcı İşaretler



# Yasaklayıcı İşaretler



# Yasaklayıcı İşaretler





# Yasaklayıcı İşaretler





**SİGARA İÇMEK YASAKTIR**



**ATEŞLE YAKLAŞMAYINIZ**

**KAYNAK, TAŞLAMA , OKSİJENLE KESİM  
İŞLEMLERİNDEN ÖNCE İŞ GÜVENLİĞİNE  
BİLGİ VERİNİZ!**



ÇUKURA  
DÜŞMEK  
YASAKTIR

DİZİCİLİK BİLİMLERİ

Hususî müsadecî haiz  
olmayan kimselerin  
girmesi yasaktır.

06/04/2010 09:05

# Uyarı işaretleri



# Uyarı işaretleri

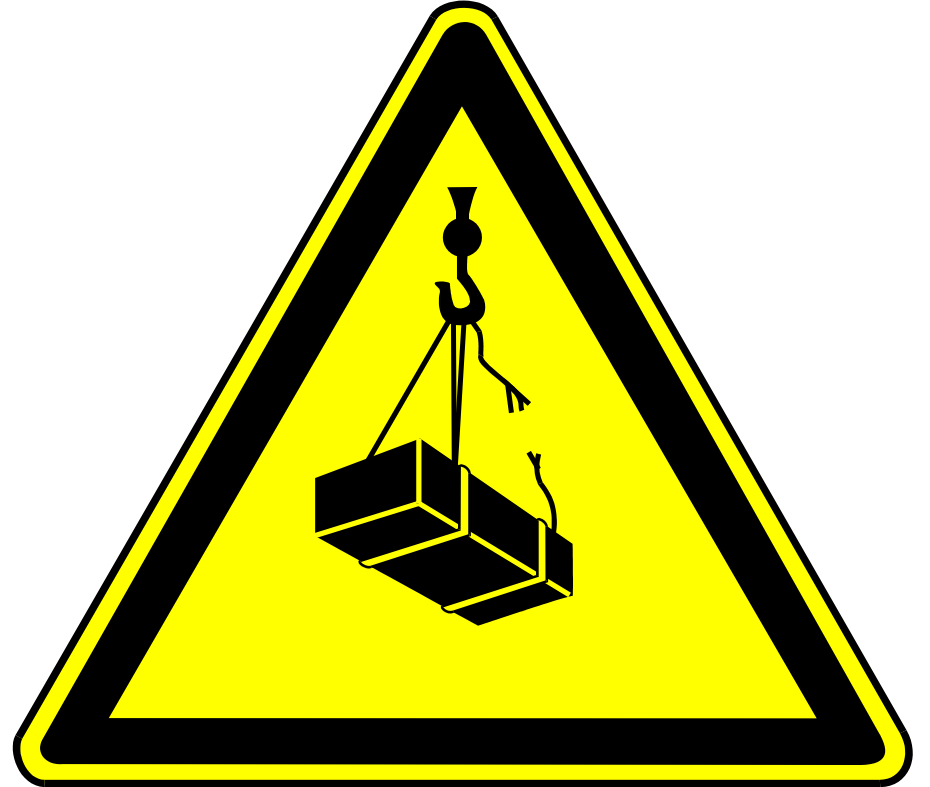

# Uyarı işaretleri





# Uyarı işaretleri



# Uyarı işaretleri



# Uyarı işaretleri



# Uyarı işaretleri





**DİKKAT**  
**HELEZONLAR ÇALIŞIRKEN**  
**ELİNİ - AYAĞINI - ALETİNİ**  
**HELEZONA**  
**YAKLAŞTIRMA**



TRAFONUN ÖNLÜNE PARÇA KOYMAYIN

İNŞAN EVİNİN KAPISINA EKMEK ATARMI

BURASIDA BİZİM EVİNİZ

06/04/2010 08:56

# Acil çıkış ve ilkyardım işaretleri

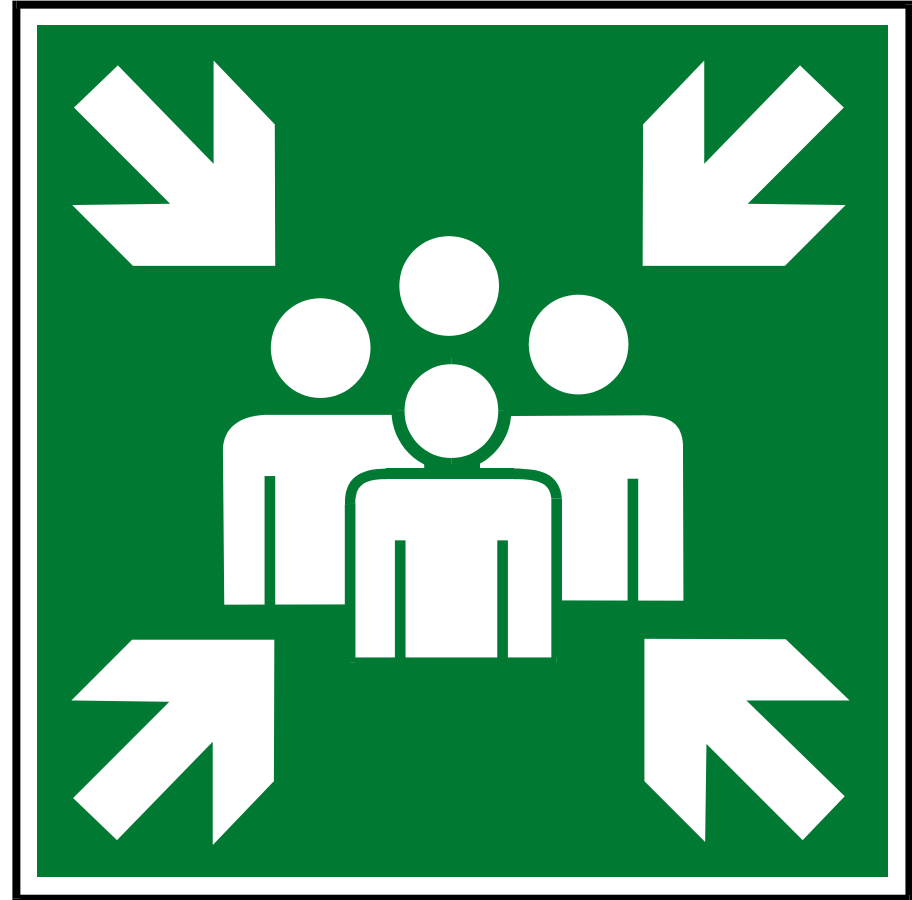
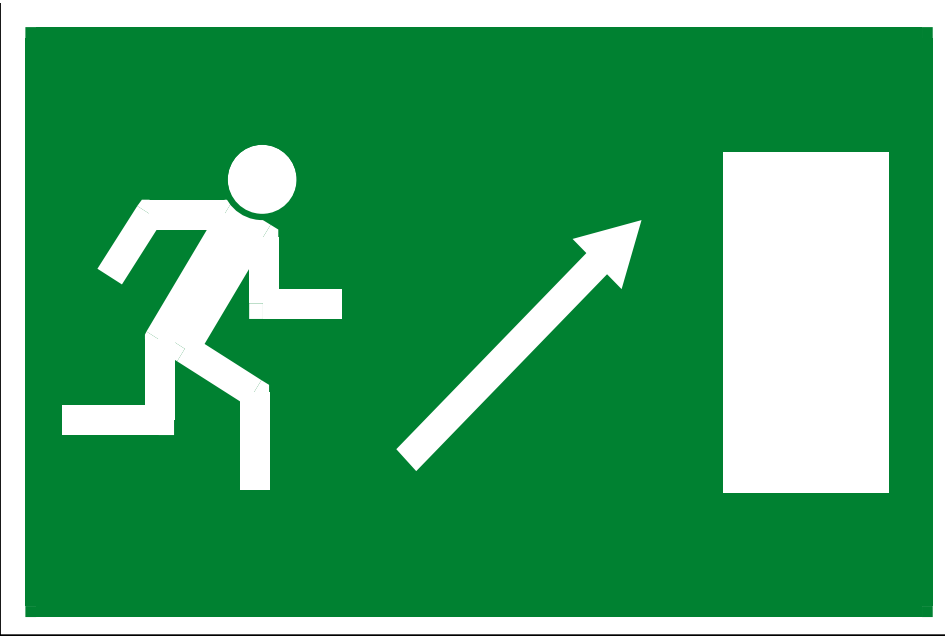



# Acil çıkış ve ilkyardım işaretleri

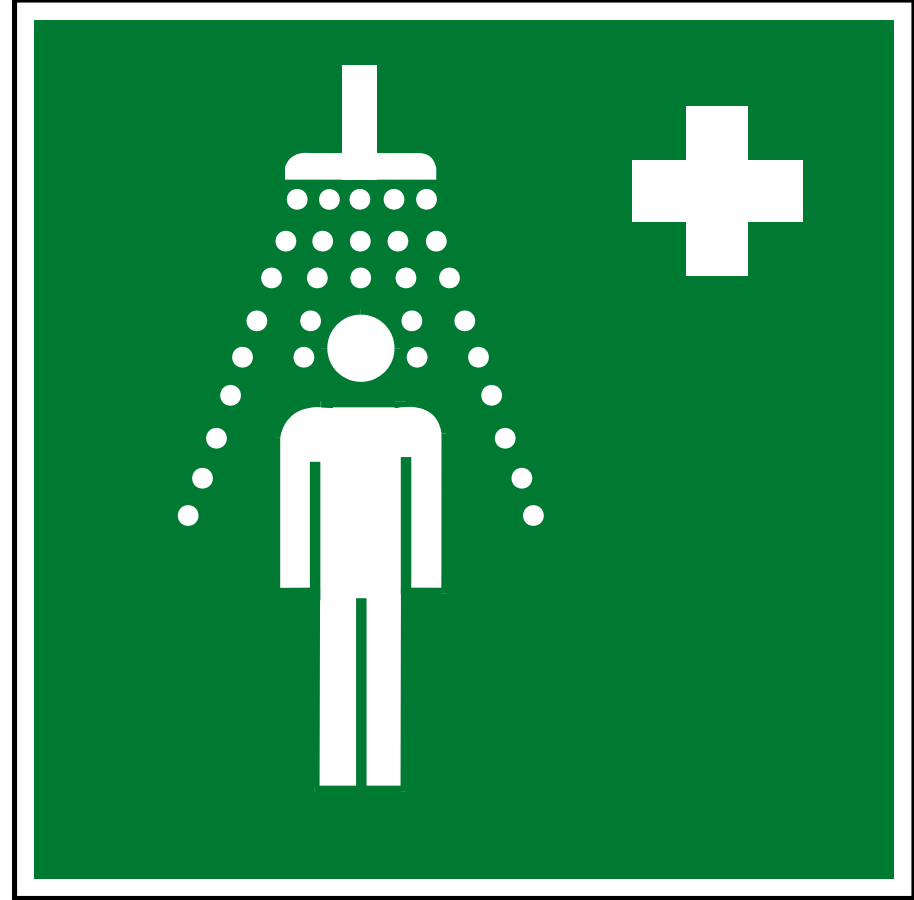
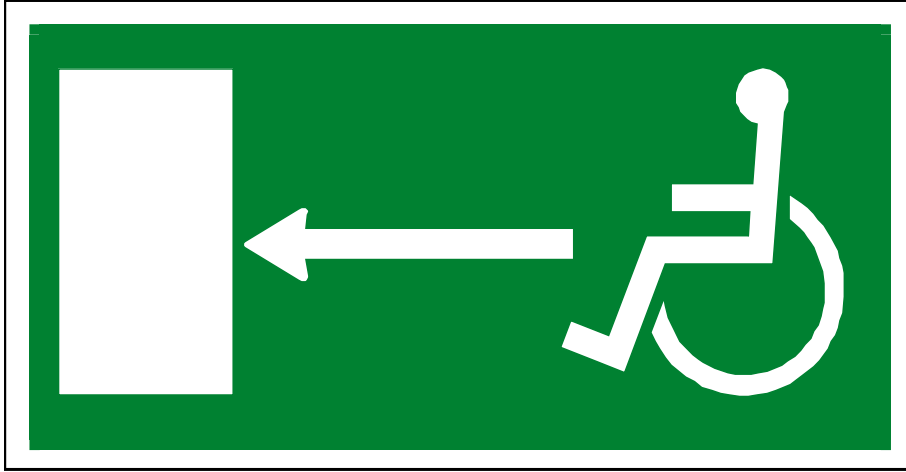

# Acil çıkış ve ilkyardım işaretleri

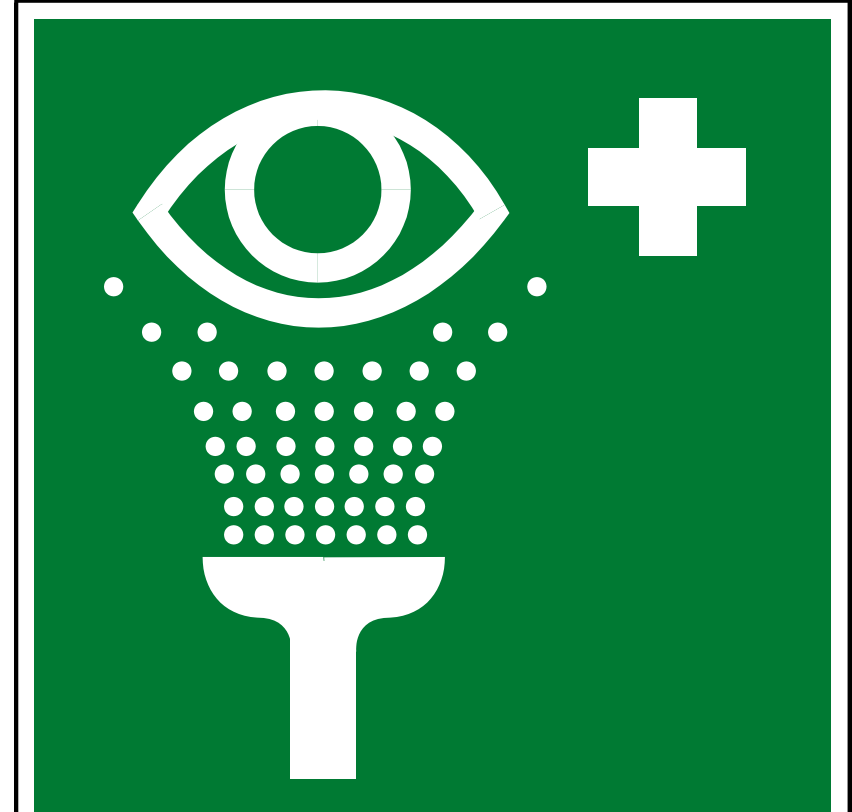

# Acil çıkış ve ilkyardım işaretleri

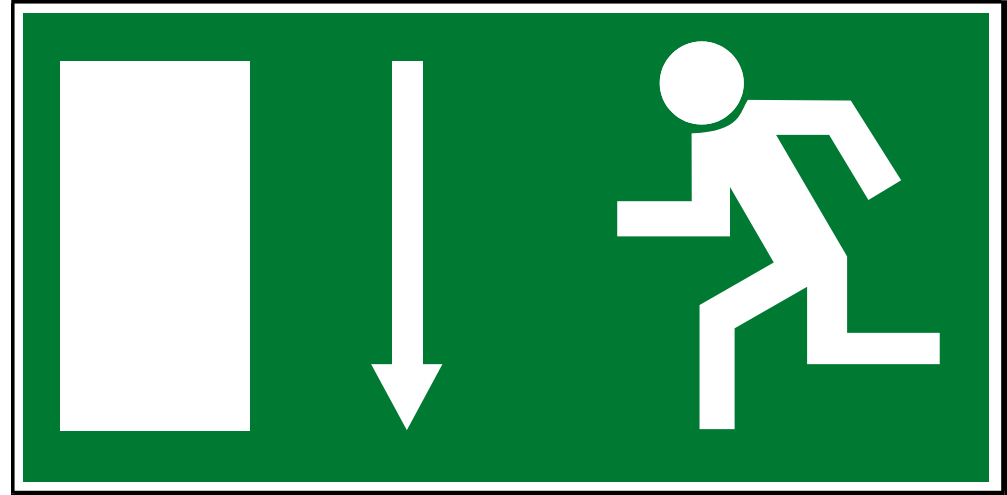
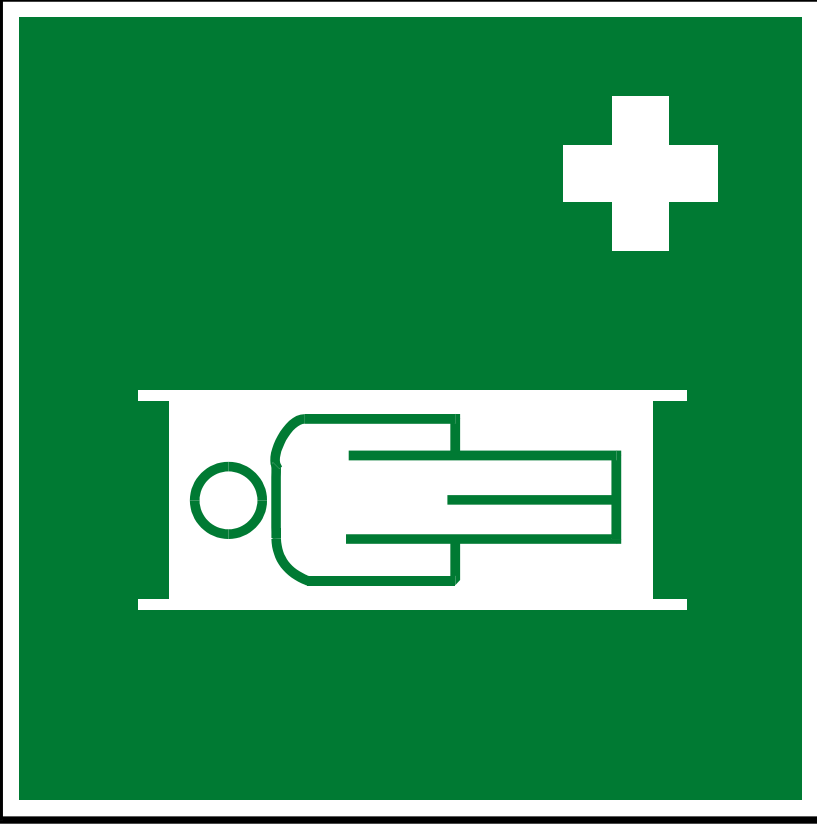

# Yangınla m¼cadele iřaretleri

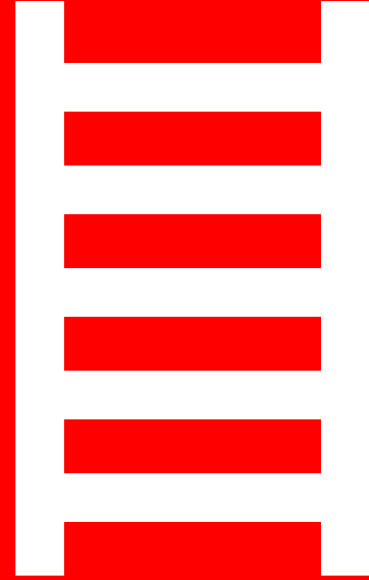
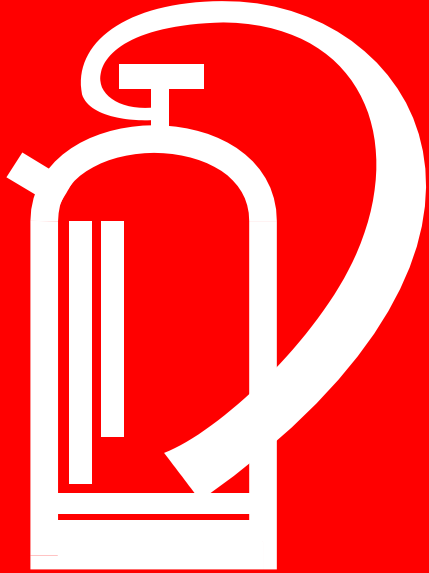

# Yangınla mücadele işaretleri

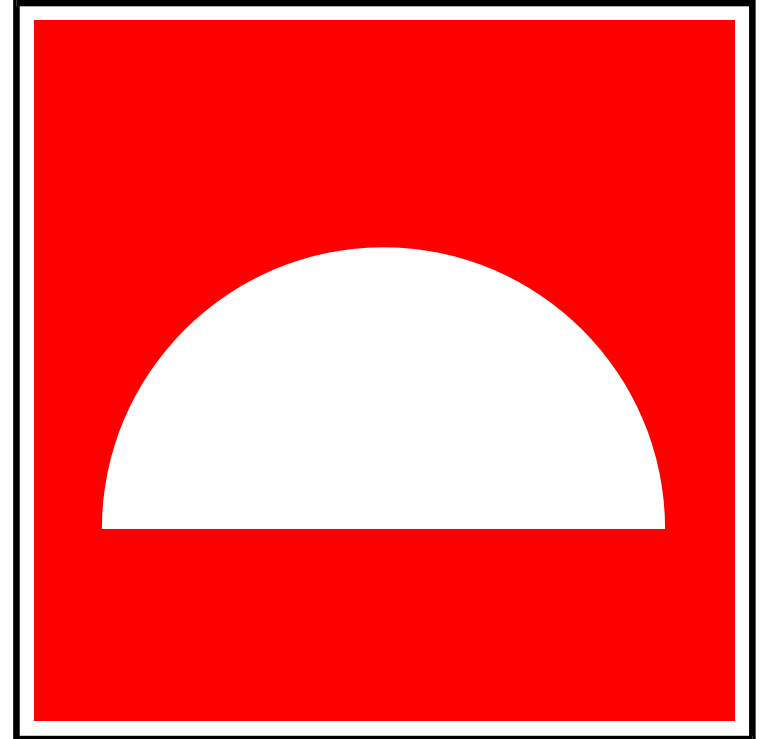
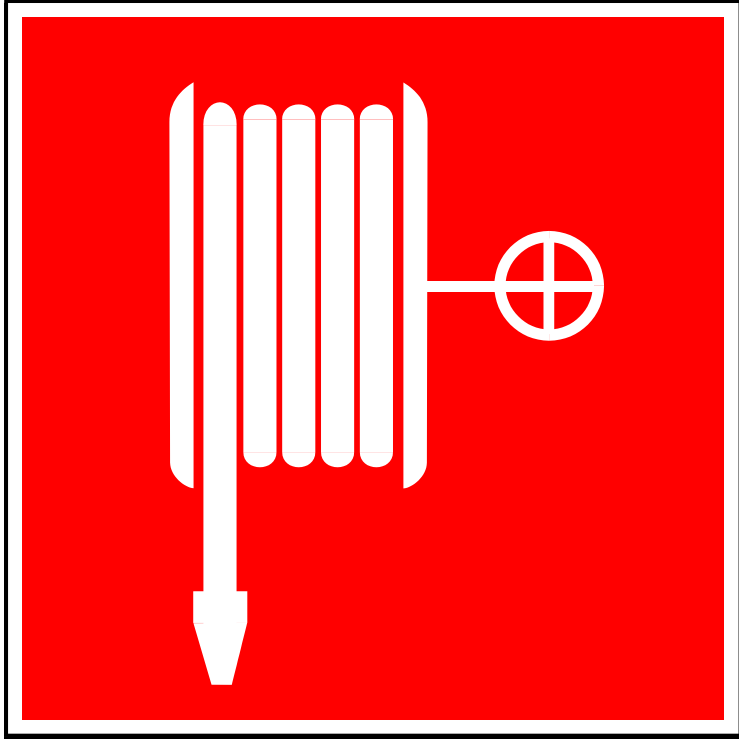



# Engeller ve tehlikeli yerlerde kullanılan iřaretler

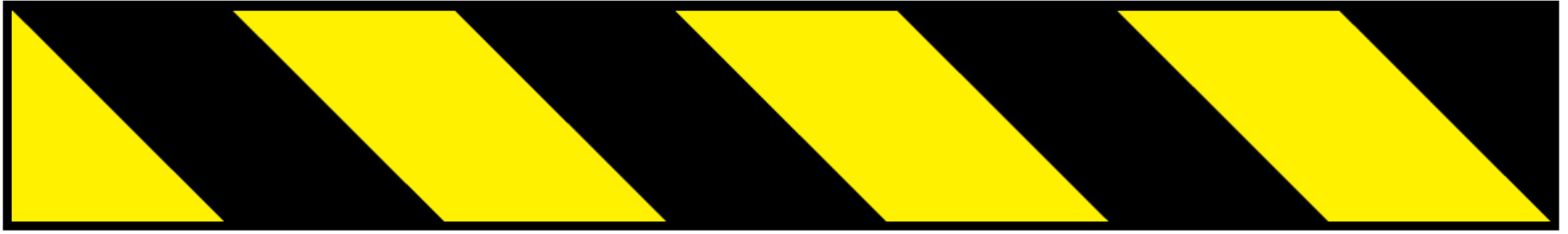

# Trafik yollarının işaretlenmesi

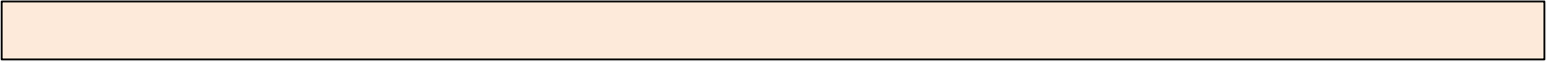



# Sanayi Gaz Tüpleri Renkleri

TS EN 1089-3:2007

Taşınabilir gaz tüpleri-Gaz tüplerinin tanıtılması  
(lpg hariç) bölüm 3: Renk kodlaması

# Sanayi Gazları Tüp Renkleri

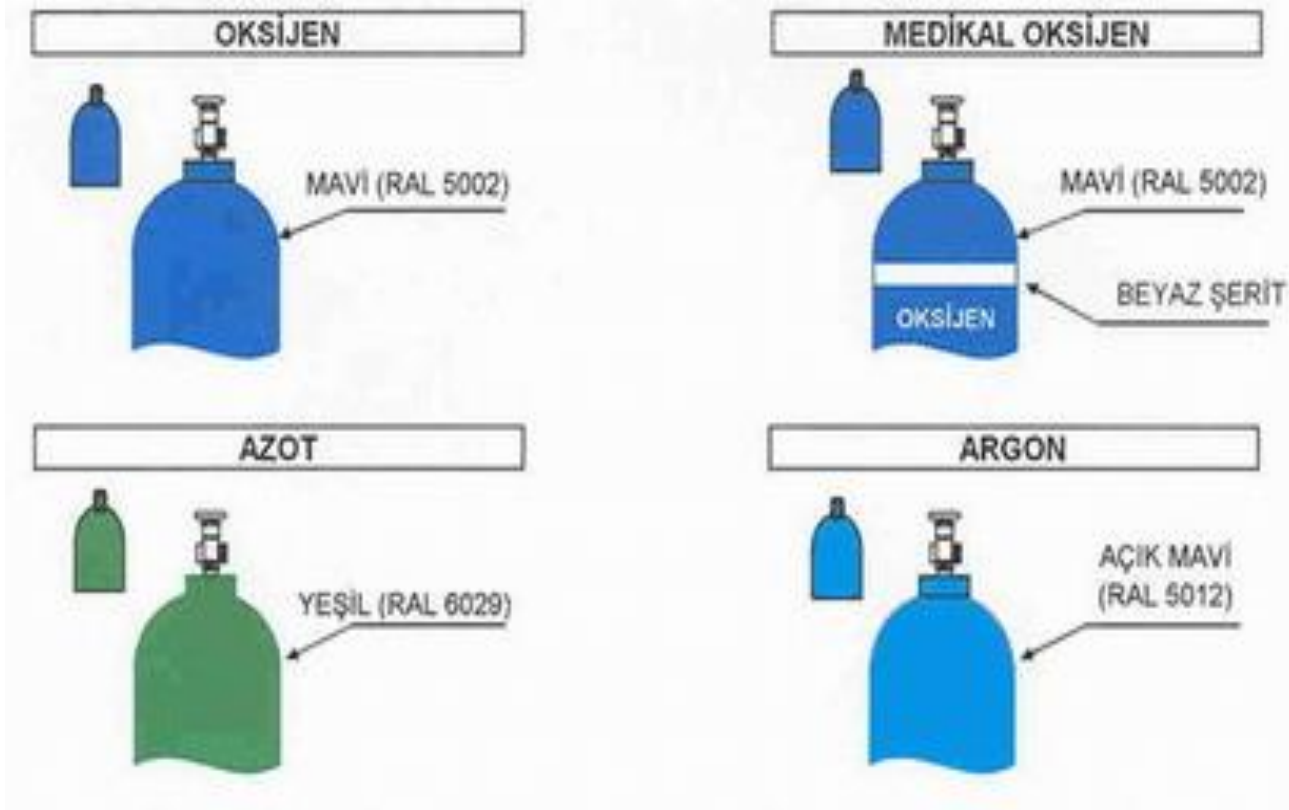

# Sanayi Gazları Tüp Renkleri

## HB SERİSİ KARIŞIM



## PROTOKSİT D'AZOT



## KARBONDİOKSİT



## HİDROJEN



# Sanayi Gazları Tüp Renkleri

HELYUM

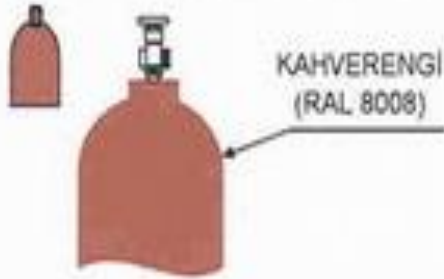

ETİLEN OKSİT+CO2



KURU HAVA



ASETİLEN



## 5-) Gaz Kaynak Donanımları, Lastik Hortumlar Standardı

- TS EN ISO 3821 Gaz Kaynak Donanımları Kaynak Yapma, Kesme ve Benzeri İşler İçin Lastik Hortumlar standardı imalat ve satış safhalarında zorunlu olarak uygulanacaktır.

# Hortum Renkleri



Oksijen

Propan

Asetilen

Asal Gaz

- Oksijen, propan ve asetilen hortumları oksî-yakıt ile kesme ve kaynak proseslerinde gaz akış hortumu olarak kullanılır.

- Asal gaz hortumları MIG/MAG ve TIG kaynak makinelerinde gaz akış hortumu olarak kullanılır.



**Yanıcı Gaz: F725201Standart Alev Tutucu (R53N)**

**Gaz Tipi: Yanıcı Gaz**

**Bağlantı: 3/8" LH**

**Basınç:**

Asetilen 1,5 bar

Dogal Gaz 5 bar

Propan 5 bar

Hidrojen 3 bar

**Ağırlık: 195 gr**

**Yakıcı Gaz: F725205Standart Alev Tutucu (R53N)**

**Gaz Tipi: Oksijen**

**Bağlantı: 3/8" RH**

**Basınç: Oksijen 30 bar**

**Ağırlık: 195 gr**

## 6-) Mekanik Tesisatlarda Renkler

- Standardı yok.



# RENK KODLAMA SİSTEMİ

**BUHAR**



**KONDENS**



**KULLANIM SICAK SUYU**



**Re-SİRKÜLASYON**

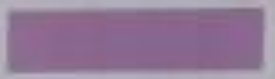

**ISITMA GİDİŞ**



**ISITMA DÖNÜŞ**



**SOĞUK SU ŞEBEKE**

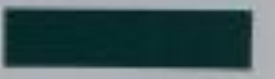

**DEMİNERALİZE**



**YUMUŞAK SU**



**HAVA HATTI**













ISITMA  
GIDIŞ

ISITMA  
DÖNÜŞ



SOĞUK SU  
GİRİŞİ



# 7-) Kişisel Koruyucu Donanımlarda Renkler

- Standardı yok.

# Baret Uygulamaları.



# İşe Yeni Başlayan Personel için Kırmızı Baret, Reflektif Yelek, İş Kıyafeti uygulaması









# 8-) Muhtelif İş Güvenliđi Uygulamalarında Renkler

- Standardı yok.

# KİLİTLEME



# ETİKETLEME







# iskele Merdiven Etiketleme

**TAG FOR SCAFFOLD**  
ERECTOR & INSPECTOR RECORD  
TO BE COMPLETED BY SUPERVISOR

LOCATION \_\_\_\_\_  
REF. NO. \_\_\_\_\_  
REQUESTED BY \_\_\_\_\_  
BUILT BY \_\_\_\_\_  
DATE & TIME \_\_\_\_\_  
INSPECTOR \_\_\_\_\_  
SIGNATURE \_\_\_\_\_

**DO NOT  
USE SCAFFOLD**

 **REMARKS**  
\_\_\_\_\_  
\_\_\_\_\_

safety@scorptek.com

**TAG FOR SCAFFOLD**  
ERECTOR & INSPECTOR RECORD  
TO BE COMPLETED BY SUPERVISOR

LOCATION \_\_\_\_\_  
REF. NO. \_\_\_\_\_  
REQUESTED BY \_\_\_\_\_  
BUILT BY \_\_\_\_\_  
DATE & TIME \_\_\_\_\_  
INSPECTOR \_\_\_\_\_  
SIGNATURE \_\_\_\_\_

**USE SCAFFOLD**

 **REMARKS**  
\_\_\_\_\_  
\_\_\_\_\_

safety@scorptek.com



**PASSED ✓**

SERIAL No.

DATE	ENGINEER	NEXT DUE DATE

**LADDER SAFETY  
INSPECTION**

**OK**

This scaffold has  
been erected to meet  
**Federal/State OSHA**  
Standards and is safe  
for all craft work.

**DO NOT ALTER**

DATE:

COMPETENT PERSON

SIGNATURE:

COMMENTS:

BRADY® 100% RECYCLABLE  
Paper Tag is 100% Recyclable



**OK**

INSPECTION-DATE AND INITIAL

---

---

---

---

---

---

---

---

**SEE OTHER SIDE**



SCAFFTAG<sup>®</sup>

**⚠ DANGER**



**DO NOT  
USE  
SCAFFOLD**

**BRADY**  
www.bradyid.com  
STH 148